

THIS COPY IS PROVIDED ON A RESTRICTED BASIS AND IS NOT TO BE USED IN ANY WAY DETRIMENTAL TO THE INTERESTS OF PANDUIT CORP.

Material	High Conductivity Seamless Copper Tube
Plating	Electro-Tin
Wire Size	4/0 AWG
Wire Type	Stranded Copper; Class B: Compact, Compressed or Concentric, Class C: Concentric
Wire Strip Length	1.0 in.
Stud Size	1/2 in.
UL Listed Wire Connector	Yes, for applications up to 35kv. Consult cable manufacturer for voltage stress relief instructions with applications greater than 2000 volts.
UL Temperature Rating	90° C
C.S.A Certified Wire Connector	Yes
Panduit Color Code on Barrel	PURPLE
Panduit Die Index No. on Barrel	P54
Alternate Industry Die Index No. () on Barrel	(15)

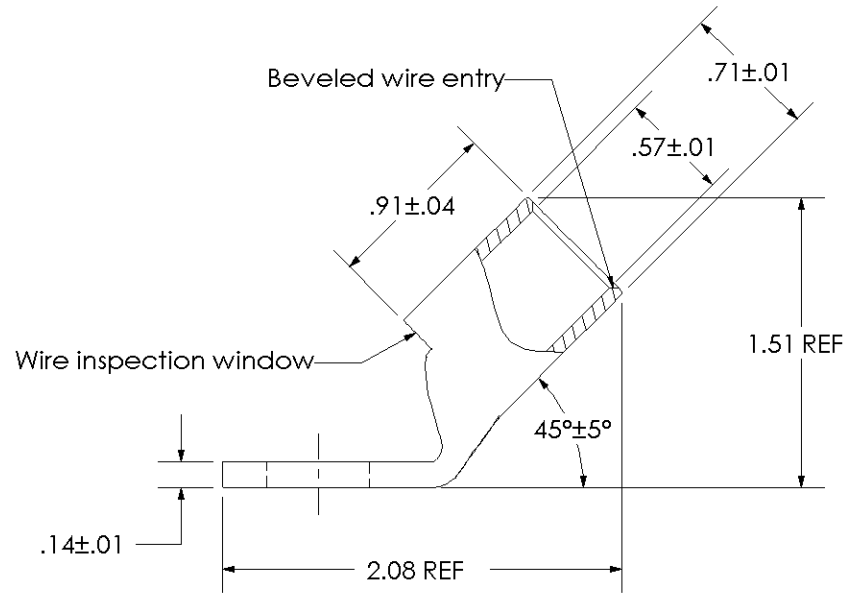
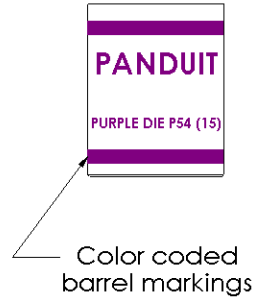
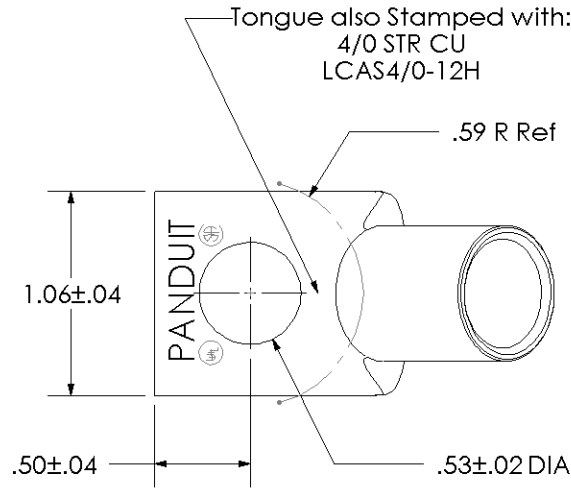

00	8/02	SAB	DRL	RELEASED	10325
REV	DATE	BY	CHK	DESCRIPTION	ECN

PANDUIT CORP. TINLEY PARK, ILLINOIS

LCAS4/0-12H-X
Copper Lug - One-Hole, Short Barrel, 45° Angle Tongue

SCALE N/A DRAWING NO / CAD FILE LCAS4_0-12H-CUST